

DT DIYA TRADERS

Filtration Made Simple



Global Quality Standards
You Can Trust



Office : Plot No. 2900/74, Sardar Patel Industrial Estate (Indokem), Near Atul Aromatic Ltd. GIDC, Ankleshwar (393002) Dist. Bharuch (Gujarat) India.

Moblie : 93271 19608 | 98250 79435 | E-mail : dpk124@yahoo.com | sales@diyadevi.com devitraders125@gmail.com Website : www.diyadevi.com

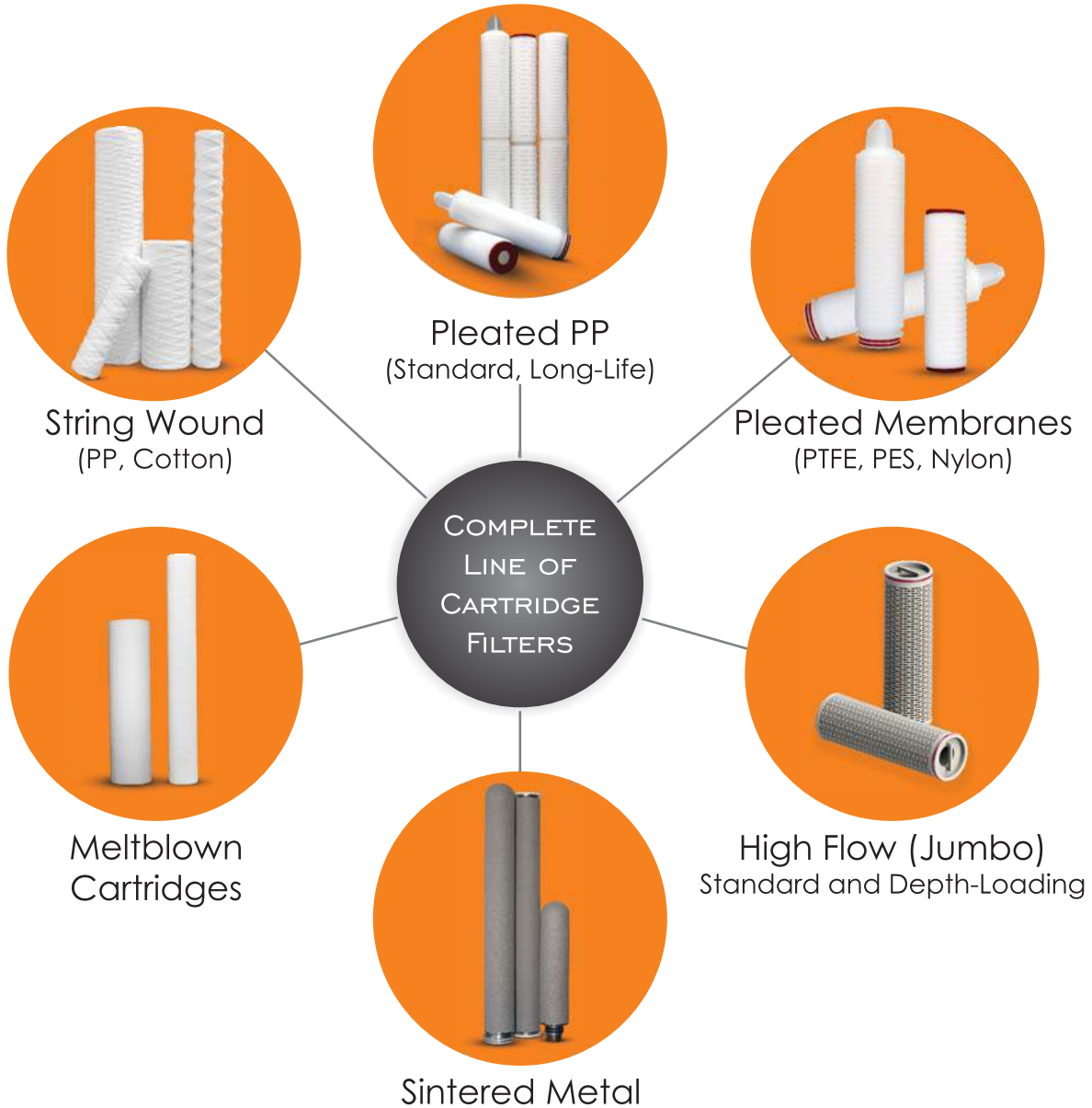

Comprehensive Cartridge Product Line

- Industry-standard products in all common sizes
- Depth-loading, long life versions in Pleated PP and High Flow
- Membrane cartridge
- One-source for the majority of your cartridge needs



Cartridge Filter Housing with PED

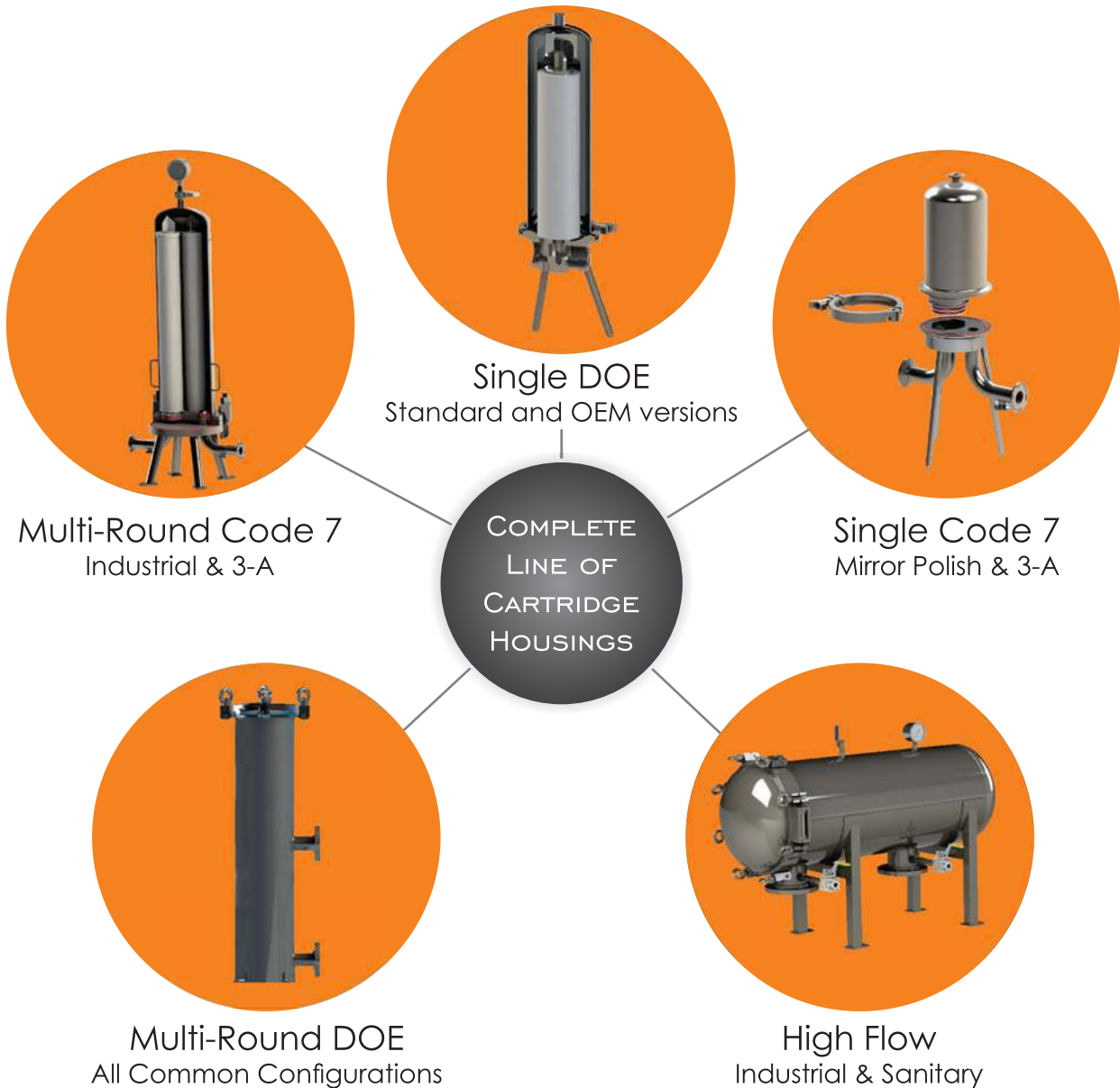

Full Range of Cartridge Housings

- Industry-standard products in all common sizes
 - Vent housing, Single Cartridges
 - Multi-round 3-52 cartridges in all end styles
- Mirror polish standard; 3-A and bead blasted available
- All materials included linings in HDPE, PP and ETFE
- CE-stamping upon request



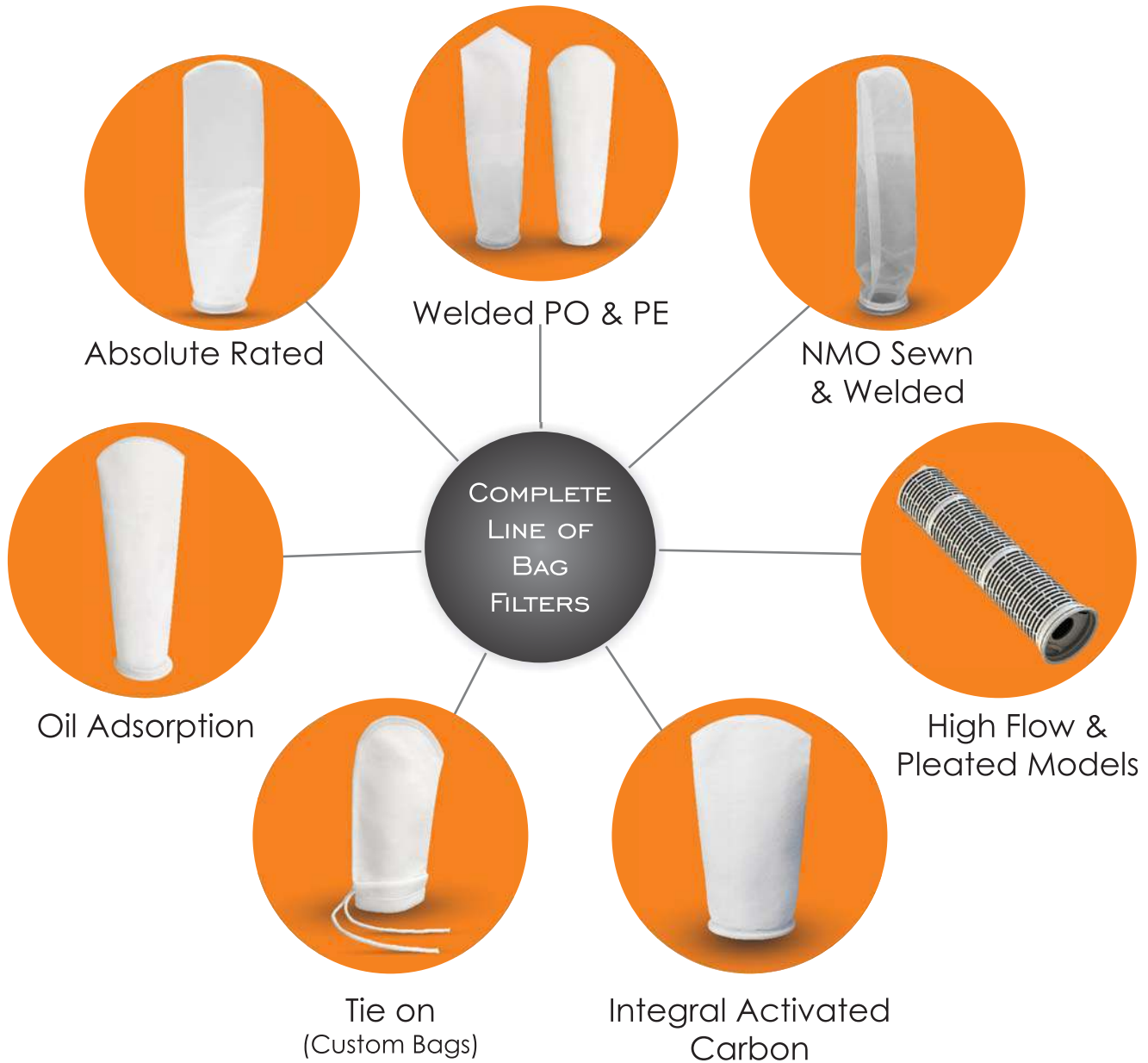

Industry-Standard Welded Bag Filters

- All sizes including “Big Blue” and “X100” sizes
- Seal rings compatible with most industry models
- Sewn bags for non-weldable materials
- Carbon versions available for combination filtration



Standard and Custom Bag Housings



Full Range of Bag Housings

- ▶ Light to heavy duty versions (8-15 bar)
- ▶ Full size range
 - Single bag: Size 1, 2, 3, 4, 5
 - Multi-bag: 2, 3, 4, 5, 6, 7, 8, 10, 13, 23-bag
- ▶ All standard options
 - Quick-Opening
 - Safety Interlocks
 - Variety of Linings
- ▶ CE-stamping upon request





All Options in Presses and Lenticular Modules

- Paper, pad and carbon media for all size and style filter presses
- Housings and systems with and without PED certification
- Carbon in granules, pads or lenticular modules
- Synthetic pads and discs for high efficiency and special applications



Presses & Lenticular Housings



Module / Lenticular Cartridge Housings

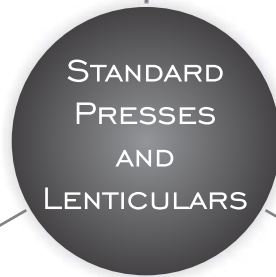

Integrated Trolleys

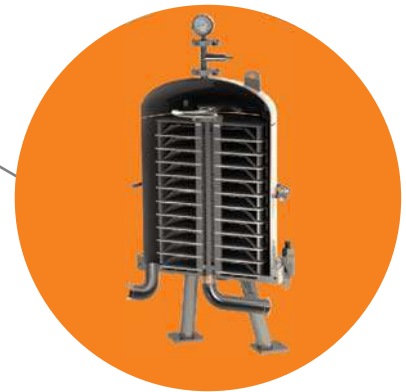

Horizontal Presses
(Sparkler Filter)

Presses for Paper, Pads and Modules

- Decades of experience with paper and pad filtration
- Presses in all common sizes: 8" - 24"
- System options in mobile or fixed configurations
- Available with CE-stamp upon request



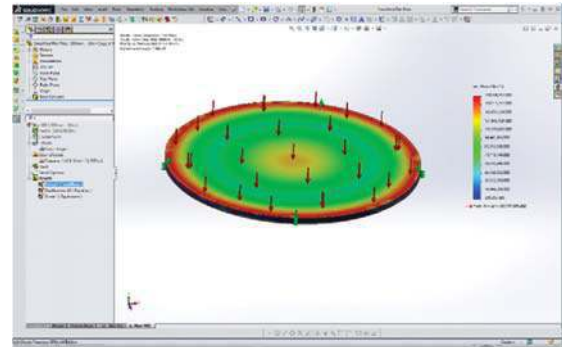
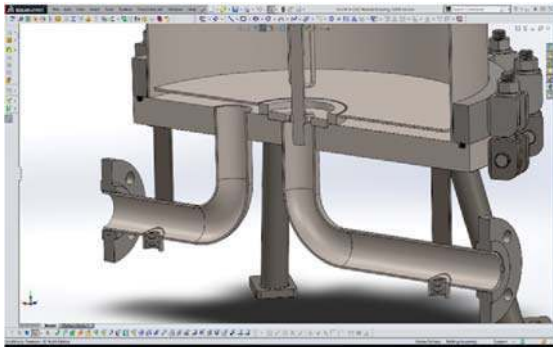

3D Design for System Integration



Combo Systems



Custom Housings



Integrated Systems

Custom Designs to Solve Your Challenges

- ▶ Manufacturing flexibility for sizes and materials
- ▶ Full 3D design for housings and systems
- ▶ Focused functions such as wine skids, integrating multiple processes with automatic or manual operations
- ▶ Custom CE-stamped system as required

